

板跨接片式电阻器

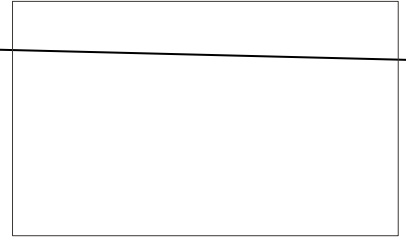

◆ 型号表示方法 Part Number

| | |

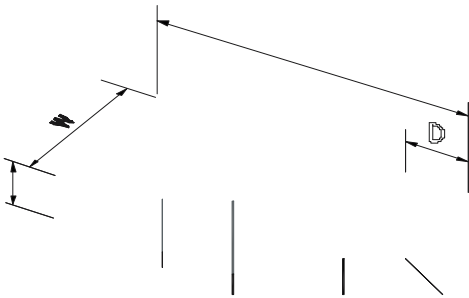

製

焊

d Solder Profile

### ◆ 特性 Characteristics

Item	Specifications	Test Methods
Solderability	95% 95% Cover Min	IEC 60115-1 4.17 245 5 3s 0.3s. Lead-free solder bath at 245 5 for 3s 0.3s.
Resistance to Soldering Heat	Max.0.5mΩ	IEC 60115-1 4.18 270 5 10s 1s. Lead-free solder bath at 270 5 for 10s 1s.
Short Time Overload	Max.0.5mΩ	IEC 60115-1 4.13 1.5 <b>2</b> 1.5×Rated Power, for 2 s.

### ◆ Packaging

Tape and Reel

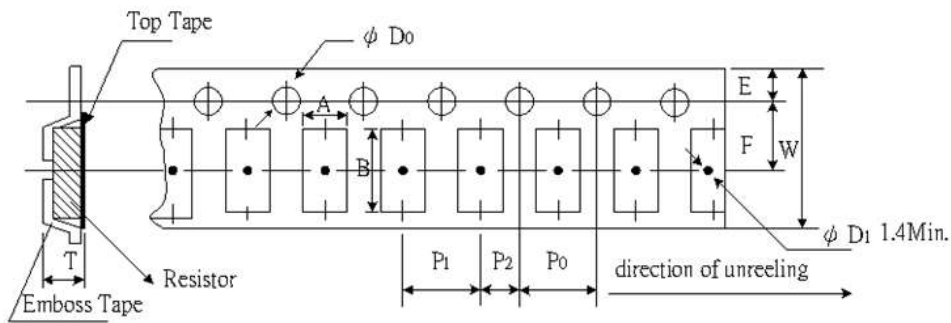

Type	A (mm)	B (mm)	W (mm)	E (mm)	F (mm)	Po (mm)	P1 (mm)	P2 (mm)	φ Do (mm)	T (mm)	Quantity (EA)
2512	3.50±0.20	6.80±0.20	12.0±0.20	1.75±0.10	5.5±0.05	4.0±0.10	4.0±0.10	2.00±0.05	1.50±0.10	1.20±0.15	4000

### ◆ 推荐焊盘

2512	C (mm)
------	-----------

### ◆ 包装 Packaging

Packaging can refer to the Appendix.

### 推荐焊盘尺寸 Reco

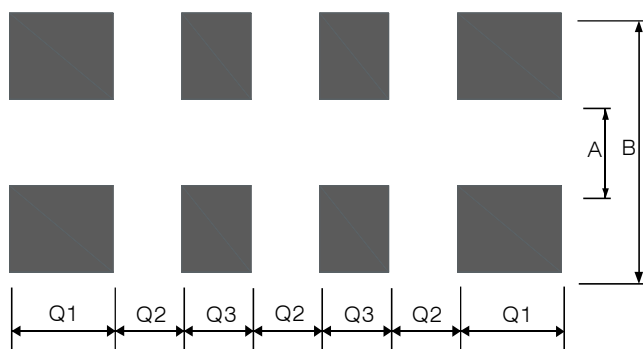

unit: mm

	A	B			
2R01					
2R02					

## ◆ 包装 Packaging

### ● Paper Taping

01005 0201 0402 2R01 4R01 2R02 4R02  
For 01005 0201 0402 2R01 4R01 2R02 4R02

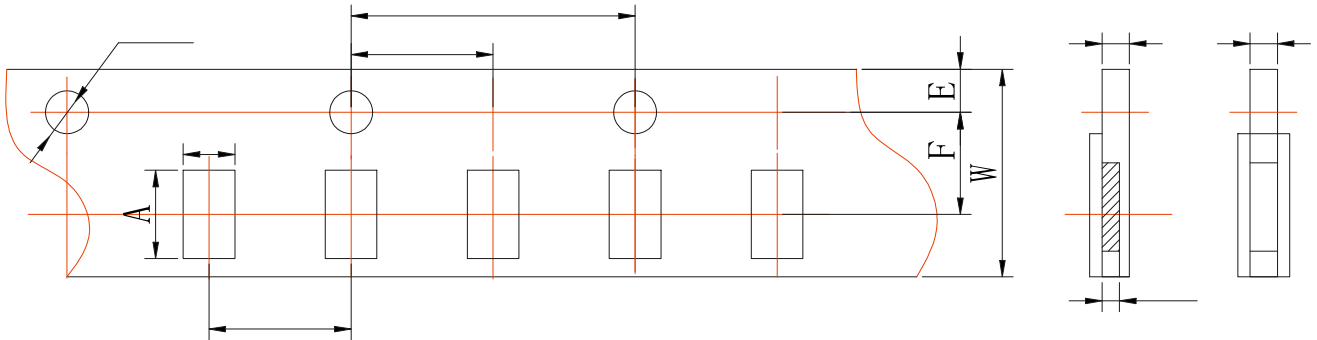

unit: mm

Type	A	B	W	F	E
01005	0.45 0.02	0.25 0.02	8.00 0.02	3.50 0.05	1.75 0.05
0201	0.70 0.10	0.40 0.10	8.00 0.20	3.50 0.05	1.75 0.10
0402	1.15 0.10	0.65 0.10	8.00 0.20	3.50 0.05	1.75 0.10
2R01	0.97 0.05	0.77 0.05	8.00 0.20	3.50 0.05	1.75 0.10
4R01	1.57 0.05	0.77 0.05	8.00 0.20	3.50 0.05	1.75 0.10
2R02	1.45 0.10	1.20 0.10	8.00 0.20	3.50 0.05	1.75 0.10
4R02	2.20 0.10	1.20 0.10	8.00 0.20	3.50 0.05	1.75 0.10

unit: mm

Type	P	P0	P1	D0	T1	T
01005	2.00 0.05	4.00 0.10	2.00 0.05	1.55 0.02	0.17 0.02	0.31 0.02
0201	2.00 0.05	4.00 0.10	2.00 0.05	1.50 0.10	0.28 0.04	0.42 0.05
0402	2.00 0.05	4.00 0.10	2.00 0.05	1.50 0.10	/	0.44 0.05
2R01	2.00 0.10	4.00 0.10	2.00 0.05	1.50 0.10	/	0.60 0.10
4R01	2.00 0.10	4.00 0.10	2.00 0.05	1.50 0.10	/	0.60 0.10
2R02	2.00 0.10	4.00 0.10	2.00 0.05	1.50 0.10	/	0.60 0.10
4R02	2.00 0.10	4.00 0.10	2.00 0.05	1.50 0.10	/	0.60 0.10

0603 0805 0508 1206 0612 1210 4R03:  
For 0603 0805 0508 1206 0612 1210 4R03:

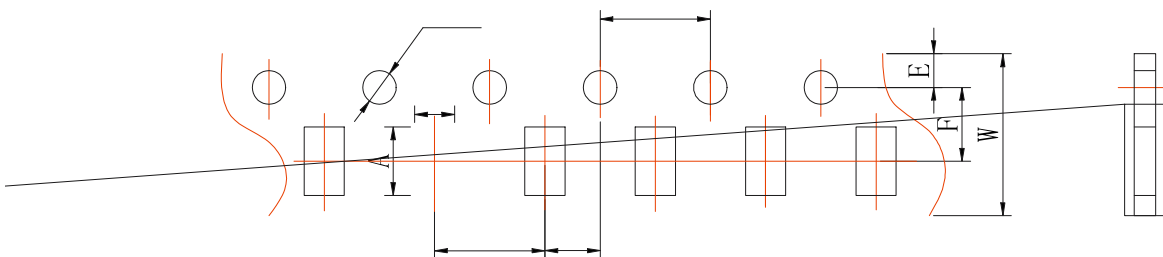

unit: mm

Type	A	B	W	F	E
0603	1.80 0.10	1.05 0.10	8.00 0.20	3.50 0.05	1.75 0.10
0805	2.30 0.10	1.50 0.10	8.00 0.20	3.50 0.05	1.75 0.10
0508	2.30 0.10	1.50 0.10	8.00 0.20	3.50 0.05	1.75 0.10
1206	3.50 0.20	1.90 0.20	8.00 0.20	3.50 0.05	1.75 0.10
0612	3.50 0.20	1.90 0.20	8.00 0.20	3.50 0.05	1.75 0.10
1210	3.50 0.20	2.80 0.20	8.00 0.20	3.50 0.05	1.75 0.10
4R03	3.50 0.20	1.90 0.20	8.00 0.20	3.50 0.05	1.75 0.10

unit: mm

Type	P	P0	P1	D0	T	
					Thick Film Resistor and Thin Film Resistor	Metal Foil Resistor
0603	4.00 0.10	4.00 0.10	2.00 0.05	1.50 0.10	0.60 0.10	0.75 0.10
0805	4.00 0.10	4.00 0.10	2.00 0.05	1.50 0.10	0.75 0.10	0.95 0.10
0508	4.00 0.10	4.00 0.10	2.00 0.05	1.50 0.10	0.75 0.10	0.95 0.10
1206	4.00 0.10	4.00 0.10	2.00 0.05	1.50 0.10	0.75 0.10	0.95 0.10
0612	4.00 0.10	4.00 0.10	2.00 0.05	1.50 0.10	0.75 0.10	0.95 0.10
1210	4.00 0.10	4.00 0.10	2.00 0.05	1.50 0.10	0.75 0.10	
4R03	4.00 0.10	4.00 0.10	2.00 0.05	1.50 0.10	0.75 0.10	

● Embossed Taping

2010 2512 1225  
For 2010 2512 1225

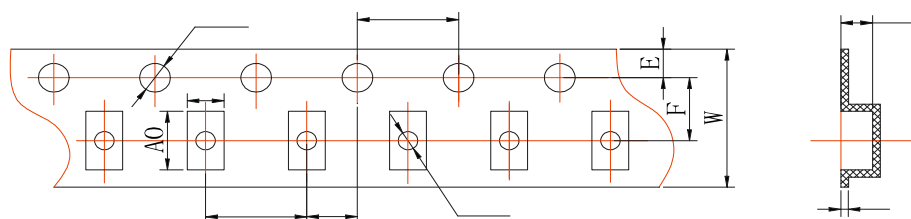

unit: mm

Type	A0	B0	W	F	E	t
2010	5.50±0.15	2.82±0.15	12.00 0.10	5.50 0.10	1.75 0.10	0.25±0.05
2512	6.78±0.15	3.45±0.15	12.00 0.10	5.50 0.10	1.75 0.10	0.25±0.05
1225	6.78±0.15	3.45±0.15	12.00 0.10	5.50 0.10	1.75 0.10	0.25±0.05

unit: mm

Type	P	P0	P1	D0	D1	K0	
						Thick Film Resistor and Thin Film Resistor	Metal Foil Resistor
2010	4.00 0.10	4.00 0.10	2.00 0.05	1.50+0.10/-0	1.50 0.10	0.84 0.10	0.84 0.10
2512	4.00 0.10	4.00 0.10	2.00 0.05	1.50+0.10/-0	1.50 0.10	0.81 0.10	1.00 0.10
1225	4.00 0.10	4.00 0.10	2.00 0.05	1.50+0.10/-0	1.50 0.10	0.81 0.10	1.00 0.10

Reel

● Packaging Quantity

Packaging style	7 7inch dia.Reel			13 13inch dia.Reel	
Type	01005	0402 2R01 2R02 4R01 4R02	0603 0805 1206 1210 4R03 0508 0612	0201 0402	0603 0805 1206
Quantity(pcs)	20000	20	R . 4	. 4	

**IEC E-24、E-96系列电阻值代码对照表**

**IEC E-24、E-96 Series Resistance Cross-reference List**

● E-24 E-24 series(  $10^n$  )

( unit 0.001 0.01 0.1 1 10 100 1k 10k 100k 1M 10M 100M 1000M )

Table One:

1.0	1.5	2.2	3.3	4.7	6.8
1.1	1.6	2.4	3.6	5.1	7.5
1.2	1.8	2.7	3.9	5.6	8.2
1.3	2.0	3.0	4.3	6.2	9.1

● E-96 E-96 series (  $10^n$  )

( unit 0.001 0.01 0.1 1 10 100 1k 10k 100k 1M 10M 100M 1000M )

Table Two:

1.00	1.33	1.78	2.37	3.16	4.22	5.62	7.50
1.02	1.37	1.82	2.43	3.24	4.32	5.76	7.68
1.05	1.40	1.87	2.49	3.32	4.42	5.90	7.87
1.07	1.43	1.91	2.55	3.40	4.53	6.04	8.06
1.10	1.47	1.96	2.61	3.48	4.64	6.19	8.25
1.13	1.50	2.00	2.67	3.57	4.75	6.34	8.45
1.15	1.54	2.05	2.74	3.65	4.87	6.49	8.66
1.18	1.58	2.10	2.80	3.74	4.99	6.65	8.87
1.21	1.62	2.15	2.87	3.83	5.11	6.81	9.09
1.24	1.65	2.21	2.94	3.92	5.23	6.98	9.31
1.27	1.69	2.26	3.01	4.02	5.36	7.15	9.53
1.30	1.74	2.32	3.09	4.12	5.49	7.32	9.76



● E ≤ 96 0603

E-96 series(0603) multiplied Cross-reference List and Resistance Cross-reference List

Table Three:

multiplied	10 <sup>0</sup>	10 <sup>1</sup>	10 <sup>2</sup>	10 <sup>3</sup>	10 <sup>4</sup>	10 <sup>5</sup>	10 <sup>6</sup>	10 <sup>7</sup>	10 <sup>-1</sup>	10 <sup>-2</sup>	10 <sup>-3</sup>
code	A	B	C	D	E	F	G	H	X	Y	Z

Table Four:

Code	E-96 E-96 resistance	Code	E-96 E-96 resistance	Code	E-96 E-96 resistance	Code	E-96 E-96 resistance
01	100	25	178	49	316	73	562
02	102	26	182	50	324	74	576
03	105	27	187	51	332	75	590
04	107	28	191	52	340	76	604
05	110	29	196	53	348	77	619
06	113	30	200	54	357	78	634
07	115	31	205	55	365	79	649
08	118	32	210	56	374	80	665
09	121	33	215	57	383	81	681
10	124	34	221	58	392	82	698
11	127	35	226	59	402	83	715
12	130	36	232	60	412	84	732
13	133	37	237	61	422	85	750
14	137	38	243	62	432	86	768
15	140	39	249	63	442	87	787
16	143	40	255	64	453	88	806
17	147	41	261	65	464	89	825
18	150	42	267	66	475	90	845
19	154	43	274	67	487	91	866
20	158	44	280	68	499	92	887
21	162	45	287	69	511	93	909
22	165	46	294	70	523	94	931
23	169	47	301	71	536	95	953
24	174	48	309	72	549	96	976

... two digits

→ 33

... 0.5%

... (0.5%)::

... stance of E-9

→ 22

→ 0

... side.

o Resistor

电流检测电阻阻值代码及标记规则

Description for Resistance Value Code and Marking of Current Sensing Thick Film Chip Resistor

•

**Application of the products in a special environment can deteriorate product performance:**

1. Use in various types of liquid, including water, oils, chemicals, and organic solvents.
2. Use outdoors where the products are exposed to direct sunlight, or in dusty places.
3. Use in places where the products are exposed to sea winds or corrosive gases, including Cl<sub>2</sub>, H<sub>2</sub>S, NH<sub>3</sub>, SO<sub>2</sub>, and NO<sub>2</sub> etc.
4. Use in places where the products are exposed to static electricity or electromagnetic waves.
5. Use in proximity to heat-producing components, plastic cords, or other flammable items.
6. Use involving sealing or coating the products with resin or other coating materials.
7. Use involving unclean solder or use of water or water-soluble cleaning agents for cleaning after soldering.
8. The substrate of chip resistors is alumina. Cracks may occur at the connection of solder (solder fillet portion) due to the difference of the coefficient of thermal expansion from a mounting board when heat stress like heat cycle, etc. are repeatedly given to them. Care should be taken to the occurrence of the cracks when the change in ambient temperature or ON/OFF of load is repeated. The occurrence of the crack by heat stress may be influenced by the size of a pad, solder volume, heat radiation of mounting board etc., so please pay careful attention to designing when a big change in ambient temperature and conditions for use like ON/OFF of load can be assumed.

5 30 30% 70%

Pr-



